

pHiX[®] compact
pH and Redox Transmitter



User Manual

Konformitetserklæring

Vi, MJK Automation A/S,
DK-2850 Nærum, påtager os
det fulde ansvar for at produktet

Declaration of Conformity

We, MJK Automation A/S,
DK-2850 Nærum, declare under
our sole responsibility that the
product

Konformitätserklärung

Wir, MJK Automation A/S,
DK-2850 Nærum, erklären in
alleiniger Verantwortung, dass
das Produkt

MJK pHix[®] pH / redox / temperature transmitter

som denne erklæring angår, er i
overensstemmelse med følgende
standard(er) eller andre
normdokument(er).

EN 50081-1:1995
EN 50082-1:1995
EN 60730

efter bestemmelserne i
direktiv

89/336/EØF
73/23/EØF; 93/68/EØF

Declaration de conformité

Nous, MJK Automation A/S,
DK-2850 Nærum, déclarons
sous notre seule responsabilité
que le produit

to which this declaration relates
is in conformity with the following
standard(s) or other normative
document(s).

EN 50081-1:1995
EN 50082-1:1995
EN 60730

following the provisions of
Directive

89/336/EWG
73/23/EWG; 93/68/EWG

Dichiarazione di conformità

Noi, MJK Automation A/S,
DK-2850 Nærum, dichiariamo
sotto la nostra esclusiva
responsabilità che l'apparecchio

auf das sich diese Erklärung
bezieht mit der/den folgenden
Nor me(en) oder normativen
Dokument(en) übereinstimmt.

EN 50081-1:1995
EN 50082-1:1995
EN 60730

Gemäss den Bestimmungen der
Richtlinie

89/336/EWG
73/23/EWG; 93/68/EWG

Declaración de Conformidad

Nosotros, MJK Automation A/S,
DK-2850 Nærum, declaramos
bajo nuestra única
responsabilidad que el producto

MJK pHix[®] pH / redox / temperature transmitter

auquel se réfère cette
déclaration est conforme à la
(aux) norme(s) ou autre(s)
document(s) normatif(s)

EN 50081-1:1995
EN 50082-1:1995
EN 60730

conformément aux dispositions
de Directive

89/336/EWG
73/23/EWG; 93/68/EWG

al quale questa dichiarazione si
riferisce, è conforme alla
seguinte normativa(e) standard
o ad altri documenti di normativa(e)

EN 50081-1:1995
EN 50082-1:1995
EN 60730

conformemente alla disposizioni
della Direzione

89/336/EWG
73/23/EWG; 93/68/EWG

al cual se refiere esta declaración,
está en conformidad con la(s)
siguiente(e) norma(s) u otros
documentos normativos

EN 50081-1:1995
EN 50082-1:1995
EN 60730

según las disposiciones de la(s)
directiva(s)

89/336/EWG
73/23/EWG; 93/68/EWG

28.09.2004



Jens Kruse

Contents

Introduction	5	Maintenance	21
Safety instructions.....	5	General	21
Repair.....	5	Intervals.....	21
Explosion hazardous areas	5	Redox electrodes.....	21
Construction	6	Cleaning of electrodes.....	21
Product identification.....	6	Electrode lifetime.....	21
Mounting.....	7	Spares	22
Electrode types.....	7	Dimensions	22
Mounting the electrode	8	Specifications.....	22
Gasket, O-ring and plug.....	8	Dimensions	22
Mechanical mounting	10	Appendices.....	23
General.....	10	Error codes	23
Open and closed systems	10	Standard transmitter	
Mounting in open channels and		configuration	23
reservoirs.....	10	HART [®] commands:.....	23
Mounting in closed systems.....	11	Accessories for mechanical	
Mounting on a pipe stub.....	12	mounting.....	24
Electrical mounting.....	13	Accessories for electrical	
General.....	13	mounting.....	25
Signal cable.....	13		
Cutting the signal cable.....			
Cutting the signal cable.....	14		
Extending the signal cable	14		
Connection examples.....	15		
Local display.....	15		
Panel display	15		
Connection to PLC/PLS.....	15		
Buffer adjustment.....	16		
General	16		
Buffer liquid	16		
Cleaning.....	17		
Buffer adjustment using the			
switch ring.....	17		
Example of buffer adjustment			
in pH 4 and 7.....	18		
Buffer adjustment using the tilt			
switch	19		

Introduction

Thank you for choosing a *pHix[®] Compact* pH / Redox transmitter.

We have done everything possible to make a pH / Redox transmitter that can fulfill all your demands.

pHix[®] Compact is very simple to install and connect, as electrode, fitting and transmitter is built together in the same NEMA 6X class enclosure. By doing so, all error sources like e.g. bad cable connections and leaking fittings are eliminated.

As *pHix[®] Compact* is equipped with an uni-on flange in one end and male thread in the other, the transmitter is very easily mounted in open tanks as well as pipes without the usual use of fittings.

You can always contact your representative or the MJK Service Hotline for advice and guidance. Also, take a look at <http://www.phix.dk>.

pHix[®] is registered trademark of MJK.

Safety instructions

- 1: Read this manual carefully.
- 2: Be aware of the environment on the installation site. Wear necessary protective equipment and follow all current safety regulations.
- 3: *pHix[®] Compact* can provide a start signal for dangerous machinery. Always ensure that connected machinery and other equipment *are effectively being put out of service* (i.e. removal of main fuses, lock main- and/or security switches in off position) before commencing setting, fault finding, service and maintenance work etc.

Repair

- 1: Repair must only made by MJK or by a service representative approved by MJK.

Explosion hazardous areas

pHix[®] Compact must not be installed in explosion hazardous areas!

Construction

pHix[®] Compact is a 4-20 mA 2-wire transmitter with power supply and measuring signal transmitted over the same two wires.

pHix[®] Compact also has HART[®] communication capabilities via the mA wires where both the primary measuring signal (pH or redox) and the secondary measurement signal can be read. HART[®] communication gives the possibility to configure nearly all parameters like measuring ranges, alarm limits, electrode parameters and also commands for buffer adjustment.

HART[®] communication requires that *pHix[®] Compact* is connected to a HART[®] communicator or a PLC with HART[®] interface.

pHix[®] Compact is delivered as standard for pH or redox measurement, but can also be delivered for other types of measurement and non-standard settings.

Product identification

Check that the item(s) delivered corresponds to the ordered item(s). The item number is printed on a label that is stuck onto the packing. Shown below is the label for a delivery including a *pHix[®] Compact* transmitter with pH electrode with zero point at pH 4,6:

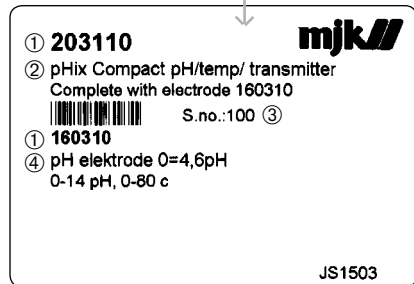

- ① Item number. ③ Serial no.
- ② Item description. ④ Electrode specification.

An identical marking is found on the pH transmitter cable:



Mounting

Electrode types

The electrode housing is marked with information about electrode type and measuring range for the actual electrode:

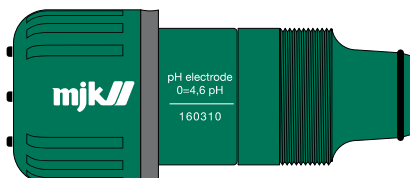

pH electrode, item no. 160310, 1 - 14 pH, 10 - 80 °C, 0 = 4.6 pH.

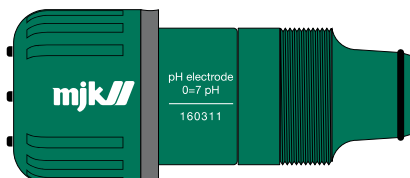

pH electrode, item no. 160311, 1 - 14 pH, 10 - 80 °C, 0 = 7.0 pH.

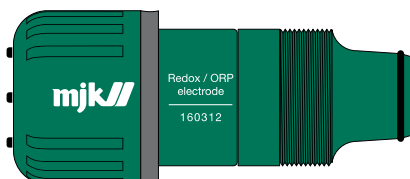

Redox electrode, item no. 160312, 0 - 80 °C.

Mounting the electrode

Upon delivery of pHix Compact®, the electrode is not mounted.

pHix Compact® is configured for the electrode type included in the delivery, and therefore it must only be used together with the electrode with which it was delivered.

pHix Compact® should be used only with the electrode type included in the delivery. Contact MJK if other electrode types should be used.

Replacement of the electrode to another of same type does not require reconfiguration.

The electrode must not become dry. Therefore, do not remove the protective cap before commissioning of pHix Compact®.

Gasket, O-ring and plug

It is very important that both gasket and O-ring and packing surfaces is clean and smooth and without cracks and scratches to avoid penetration of liquid in the center plug connection.

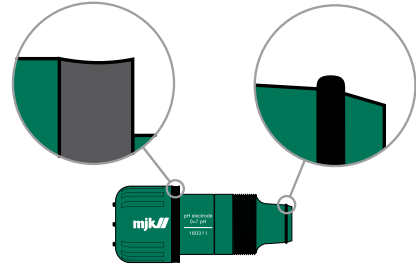

Check that gasket and O-ring are complete and clean and that they are placed correctly.

Likewise, the connectors in both transmitter and electrode should be absolutely clean and dry. Eventually use a dry cloth.

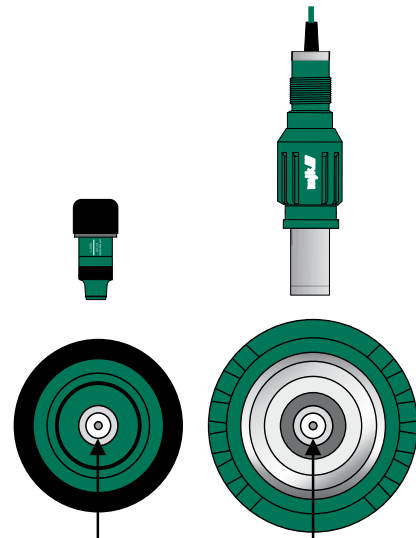

Check that the connectors are absolutely clean and dry.

- 1: Smear the O-ring in acid-free grease or Vaseline.
- 2: Check that the O-ring is placed correctly in the recess of the new electrode.
- 3: Check that the hole for the electrode in the *pHix*[®] *Compact* is completely dry – if necessary use a dry cloth.
- 4: Screw in the new electrode and tighten

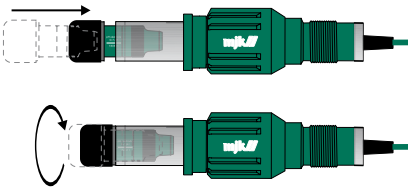

by hand.

Do not use tools!

- 5: Finally, *pHix*[®] *Compact* must be buffer adjusted prior to commissioning. See pg. 16.

Mechanical mounting

General

pHix[®] Compact is made from Ryton (PPS) and stainless steel (EN 1.4404 / ASTM 316L), and has because of this a tremendous resistance against chemicals.

pHix[®] Compact can be used without any further preparation for measuring in solvents and strong basic or acid liquids.

Open and closed systems

pHix[®] Compact is designed for measuring in both open and closed systems.

Open systems is e.g. gutters, wells, and reservoirs. Closed systems is e.g. pipe systems or tanks/vessels.

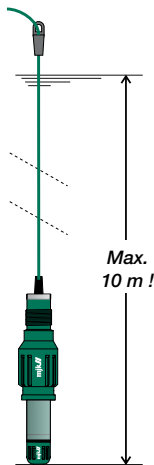

pHix[®] Compact has **class IP 68 enclosure**, and therefore withstands submersion into open system to a max. pressure of **1 bar / 10 mWG.**

Mounting in open channels and reservoirs

Due to the lifetime of the electrode and measurement accuracy, the following should possibly be complied with when mounting pHix[®] Compact.

- 1: pHix[®] Compact should be mounted on a location with a good liquid circulation.
- 2: The electrode tip should be minimum 30 cm below the liquid surface.
- 3: The electrode tip must not touch the bottom.

Suspended in the cable

If the liquid is flowing relatively slow and therefore giving no risk of pHix[®] Compact hitting the side of the channel/reservoir, pHix[®] Compact may be suspended in the cable by means of a cable bracket.

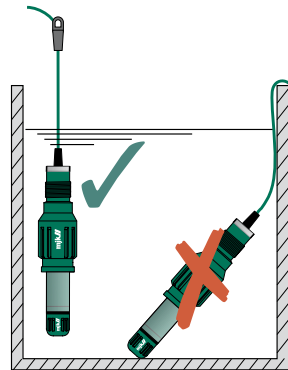

pHix[®] Compact is submerged directly into the liquid and is suspended in the cable by means of a cable bracket (item no. 560916).

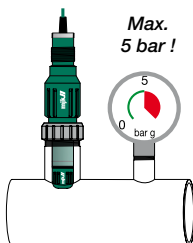

pHix[®] Compact conforms to **pressure class PN 5**, and can therefore be mounted in closed systems with a working pressure of **max. 5 bar.**

Mounted on a pipe end

When measuring in e.g. open tanks, inlet wells or gutters where strong currents can occur, *pHix[®] Compact* should be firmly fixed.

Fixed mounting can be made by means of a pipe with 5/4" inner thread (ISO 228-1), and screw *pHix[®] Compact* directly into the pipe.

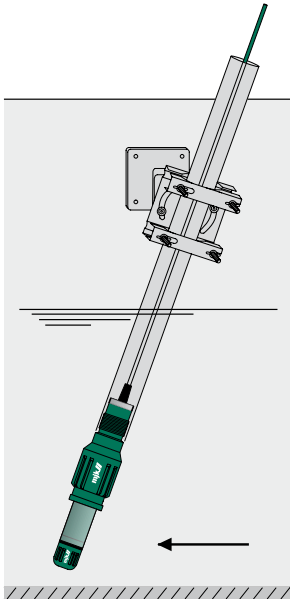

pHix[®] Compact mounted directly on a immersion bracket (item no. 155205), which is fastened with universal bracket (item no. 200205) and wall bracket (item no. 200215).

Mounting in closed systems

The electrode is filled with a liquid which should cover the membrane internally at all times. Therefore, *pHix[®] Compact* should not be mounted in angles exceeding 75 ° from vertical.

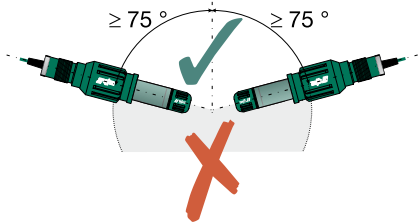

Because of the liquid inside the electrode, pHix[®] Compact should always be mounted in angles less than 75 ° from vertical.

pHix[®] Compact can be screwed into a pipe stub with 2" outer thread by means of an union (item no. 521409), that is placed over the housing flange after removal of the switch ring.

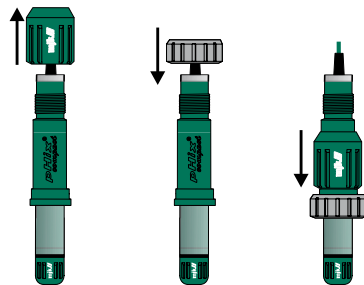

Pull off the switch ring.

Put on the union.

Put on the switch ring - if needed.

The switch ring is only used for buffer adjustment (calibration), but it is also possible to perform a buffer adjustment without using the switch ring. See also pg. 16, "Buffer adjustment".

Mounting on a pipe stub

In order to ensure a tight seal and correct function of *pHix[®] Compact*, the following should be complied with:

- 1: The pipe stub must be flush and free of scales, burrs etc.
- 2: The pipe stub must have a length so that the tip of the electrode is exposed approximately 10 mm into the liquid.
- 3: Take care to have adequate room for mounting and removal of *pHix[®] Compact*.
- 4: The working pressure of the system must not exceed **5 bar g**.
- 5: The working temperature of the system must not exceed **80 °C**.

See also the following illustrations for correct adaptation to the pipe system.

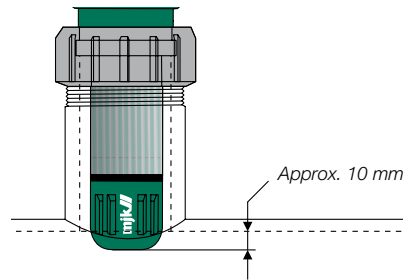

pHix[®] Compact is mounted correctly when the electrode tip is exposed approximately 10 mm out from the inner lining of the pipe.

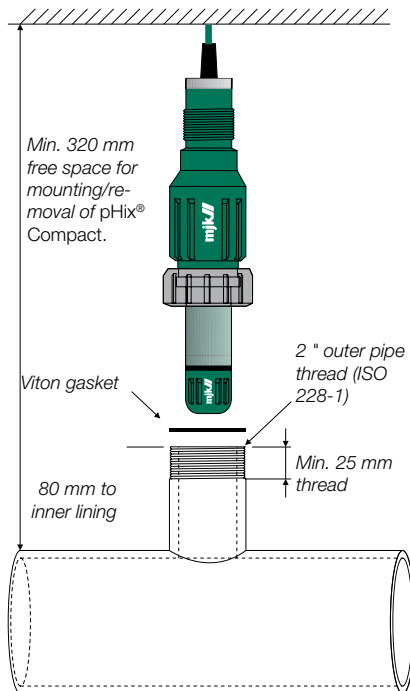

*Max. working pressure = 5 bar g.
Maks. working temperature = 80 °C.*

Electrical mounting

General

pHix[®] Compact must not be installed in explosion hazardous locations!

pHix[®] Compact should be connected to an active 4-20 mA input or be supplied from a separate 12 - 30 VDC voltage source.

Max. power consumption is 50 mW.

pHix[®] Compact's 4-20 mA output(s) is galvanically separated from the liquid.

Signal cable

pHix[®] Compact comes with either 1 or 2 galvanically separated signal outputs.

Note:
 PHix Compact is delivered with cables made of PVC or PUR.
 Check the type of cable according to the specifications before connecting pHix Compact.



pHix[®] Compact with 1 x 4-20 mA output for pH or redox measurement.

Nr.:	Designation:	PVC Cable -> 2005 Color:	PVC Cable 2006 -> 07 Color:	PUR Cable 2007 -> Color:	Signal:
1	Shield				
2	+ 12-30 V DC	Red	Red	1 Black	pH- or redox signal
3	- 4-20 mA	Black	Black	2 Black	Output 1



pHix[®] Compact with 2 x 4-20 mA outputs, 1 for pH or redox measurement and 1 for temperature measurement.

Nr.:	Designation:	PVC Cable -> 2005 Color:	PVC Cable 2006 -> 07 Color:	PUR Cable 2007 -> Color:	Signal:
1	Shield				
2	+ 12-30 V DC	Red	Red	1 Black	pH- or redox signal
3	- 4-20 mA	Black	Black	2 Black	Output 1
4	+ 12-30 V DC	Yellow	Orange	Grey	Temperature signal
5	- 4-20 mA	Orange	Brown	Brown	Output 2

Cutting the signal cable

The cable comes with stripped wire ends ready for mounting.

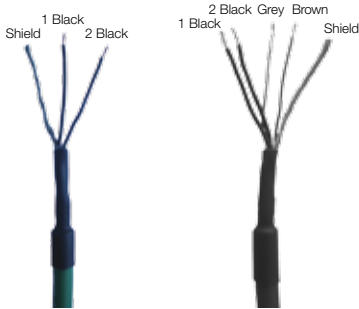

Uncut cable end for pHix[®] Compact with 1 respectively 2 signal outputs.

Besides the signal wires, the cable also contains wires solely used for service purposes and software upgrades.

These cables are exposed when the cable is cut.

The cable for a pHix[®] Compact with dual outputs is cut and the service wires are exposed.

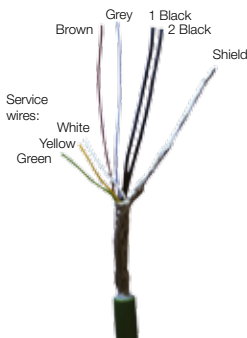

***The service wires must not be used !
Only the signal wires (1 black + 2 black / grey + brown) and shield may be used!***

Extending the signal cable

There are no specific demands to the cable that may be used for extending the existing cable, except that it should be shielded and that the voltage drop should not be too big.

pHix Compact[®] is a passive transmitter. Considerations should be taken regarding the voltage drop over the signal cable.

The supply voltage on the site must not drop below 12 V DC at maximum current (20 mA.)

In order not to compromise operational reliability, the cables should be interconnected by means of a watertight connection box (item no. 200590).

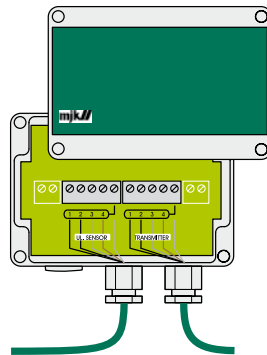

MJK connection box (item no. 200590).

Connection examples

Local display

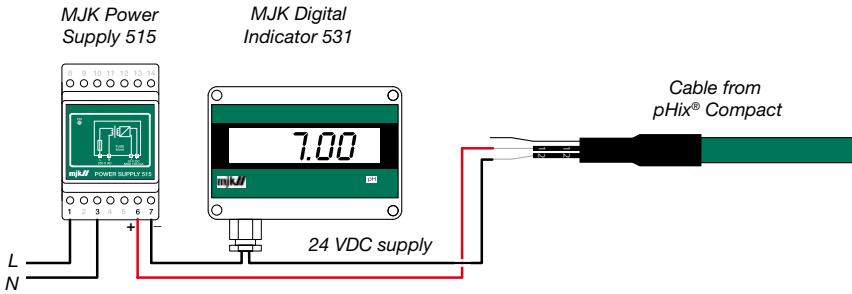

Panel display

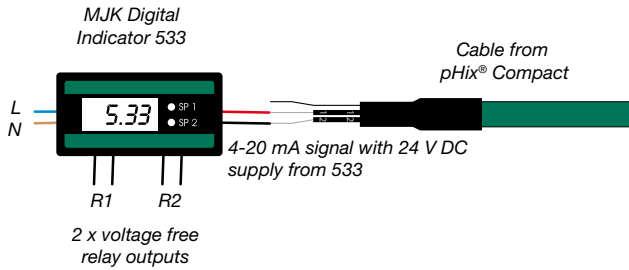

Connection to PLC/PLS

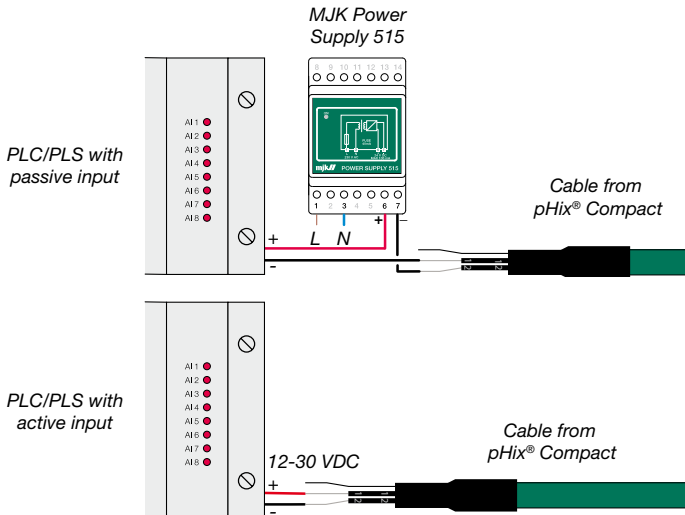

Buffer adjustment

General

In order to ensure a precise and stable pH measurement, *pHix[®] Compact* must be buffer adjusted with regular intervals.

Buffer adjustment is a calibration, which is carried out in practice by dipping *pHix[®] Compact* in solutions (buffers) with known pH values. The calibration is made by using these known pH values as a reference point.

pHix[®] Compact is buffer adjusted using 2 buffers with pH values of 4 and 7 (acidic range) or pH values of 7 and 10 (alkalic range). For measurements around pH 7 (neutral) both buffers can be used.

The sequence of different pH buffer solutions is not important. *pHix[®] Compact* automatically detects which buffer is used for adjusting the point of origin, and which buffer is used for adjusting the slope (sensitivity).

The first reference point sets the correct zero point for the measurement curve, and the second reference point sets the correct slope for the measurement curve.

pHix[®] Compact is as standard delivered to use buffer values at the values 4, 7 and 10, but other values can be chosen via HART[®] communication.

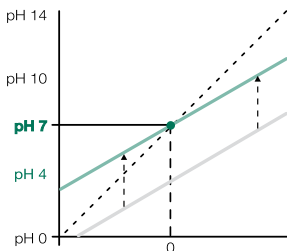

First buffer adjustment with pH 7 as reference.

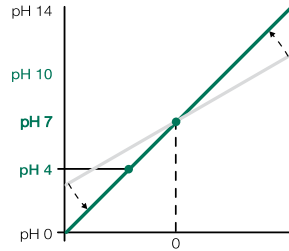

Second buffer adjustment with pH 4 as reference.

Buffer liquid

Buffer liquid is delivered as ready-to-use solutions with the pH values 4, 7 and 10.

During the buffer adjustment, *pHix[®] Compact* is calibrated in accordance with the pH values of the buffer solutions. It is therefore important to use as accurate buffer solutions as possible, i.e. a pH 7 buffer solution really has a pH value of exactly 7.



MJK delivers buffer solutions for both pH og redox calibration.

The pH value of the buffer liquid is dependant of the temperature, and the stated pH value is valid at 25 °C.

Buffer liquid has limited lifetime. Bufferliquid for pH 4 and 7 has a life time of approx. 1 year, and buffer liquid for pH 10 is so-mewhat shorter.

Note, that buffer liquid with pH 10 is very unstable, and should therefore be disposed of no more than 1 hour after it has been poured from the bottle.

Cleaning

Before initiation of a buffer adjustment, the electrode should be rinsed in running water and additionally in demineralized water before the electrode is lowered into the buffer liquid - and again between every step in the buffer adjustment process.



Use only fresh buffer solutions! Dispose of any used buffer liquid.

Take care that transmitter, electrode and buffer solution has the same temperature - preferably approx. 25 °C.

Put eventually pHix[®] Compact in a bucket of lukewarm water before commencing a buffer adjustment.

Buffer adjustment using the switch ring

Remember to clean the electrode as described in the previous section!

When the switch ring has been put on for at least 10 minutes, it will only be possible to buffer adjust pHix[®] Compact with the switch ring.

The switch ring has 4 positions, and must only be set to one of these positions in order to obtain correct function:

Pos.: Function:

M	Measurement. The switch ring should always be in this position during normal service (measuring) This is indicated by the LED that is flashing for approx. every 5 seconds.
4	Buffer adjustment in buffer with pH value pH 4.
7	Buffer adjustment in buffer with pH value pH 7.
10	Buffer adjustment in buffer with pH value pH 10.

If the switch ring is set to one of the positions 4, 7 or 10, the LED will give out 3 short flashes every 5 seconds.

If pHix[®] Compact is being put into a buffer liquid with the same value as the switch ring is set to, pHix[®] Compact will automatically begin to scan for a buffer with the same value. When the value is found, pHix[®] Compact will automatically set the 0-point or span to the correct value, and the LED will indicate this with 2 short flashes every 5 seconds.

pHix[®] Compact is now ready either for measurement or for another buffer adjustment at another pH value.

pHix[®] Compact determines automatically if zero point or span need to be adjusted depending of the electrode's zero point and the preceding buffer values.

If pHix[®] Compact cannot find the pH value for the selected buffer solution, it will go into alarm condition, which is indicated with continuous LED flashes every second.

Example of buffer adjustment in pH 4 and 7

- 1: With the switch ring in position 'M', flush the electrode tip in demineralised water. (The LED gives 1 short flash every 5. sec.)
- 2: Turn the switch ring from position 'M' to position '7', and dip the electrode tip into the pH 7 buffer solution. (The LED will now begin to give 3 short flashes every 5 sec.)

When the buffer adjustment has finished successfully, the LED will start to give 2 short flashes every 5. sec.

The zero point is now set.

- 3: Turn the switch ring from position '7' to position '4', and dip the electrode tip into the pH 4 buffer solution. (The LED will now begin to give 3 short flashes every 5 sec.)

When the buffer adjustment has finished successfully, the LED will start to give 2 short flashes every 5. sec.

The span angle is now set.

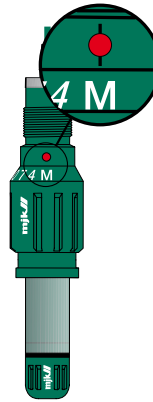

*In service (measurement).
1 flash every 5. second.*

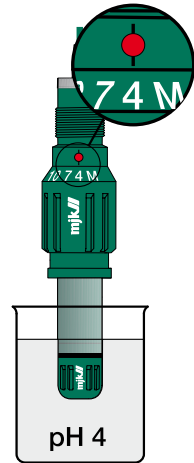

Buffer adjustment in pH 4 buffer.

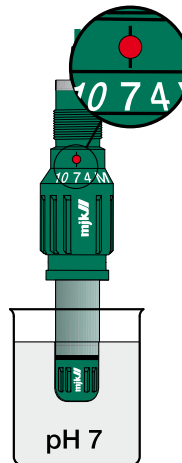

Buffer adjustment in pH 7 buffer.

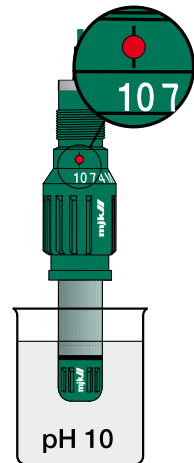

Buffer adjustment in pH 10 buffer.

Buffer adjustment using the tilt switch

Remember to clean the electrode as described in the previous section!

Only the built-in tilt switch is active, when the switch ring has been removed for more than 10 minutes.

The tilt switch inside *pHix[®] Compact* detects when the electrode tip is turned upwards. When the electrode tip has been turned upwards in more than 30 seconds, *pHix[®] Compact* will go into buffer adjustment mode.

Proceed as described:

Remove *pHix[®] Compact* from the process, rinse the electrode, and turn the electrode upside down.

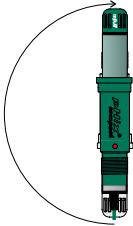

The buffer adjustment mode is initiated after approx. 30 seconds - this is indicated by the LED with 3 short flashes every 5 seconds.

If *pHix[®] Compact* is dipped into a buffer solution with a value of 4, 7 or 10 pH, *pHix[®] Compact* automatically search for a buffer

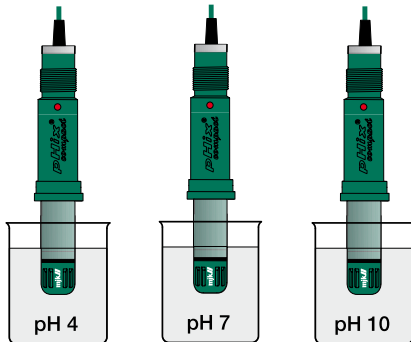

with one of those values. When the correct value is found, the zero point or span will automatically be set to the right value. The LED will give 1 short flash every 5 seconds for indication of a successful calibration.

pHix[®] Compact is now ready to be put into service or for another buffer adjustment with another pH value.

If a new buffer adjustment to another (or same) pH value, *pHix[®] Compact* is simply turned upside-down again with the electrode tip pointing upwards in approximately 30 seconds until the LED gives 3 short flashes every 5 seconds, whereafter above procedure is repeated.

If *pHix[®] Compact* cannot find the correct value for the selected buffer liquid, the transmitter will go into fault condition indicated by a flash every second.

The *pHix[®] Compact* software determines automatically whether it is the zero point or the span that need adjustment depending on the zero point value of the electrode and the preceding buffer values.

Maintenance

General

A pH or redox measuring system require maintenance with regular intervals.

Cleaning and buffer adjustment (calibration) is a normal and necessary maintenance that should be carried out regularly.

Intervals

The interval between buffer adjustments and cleaning is depending widely on the working conditions. Therefore, the easiest way to find the most appropriate cleaning interval is by feeling one's way.

For instance, start out with cleaning and buffer adjustment every week.

If the measurement is unchanged or just slightly changed after the buffer adjustment, the electrode were not dirty or just slightly dirty, and the cleaning interval can be changed to 2 weeks and after that 1 month.

The intervals are equally reduced if the electrodes are very dirty and the measurement is significantly changed after buffer adjusting.

There are no general guidelines to cleaning and adjustment, men in most cases a monthly adjustment is sufficient.

Before beginning a buffer adjustment, the electrode must be thoroughly washed, first in running water, if necessary a degreasing fluid like for example 10% hydrochloric acid solution, and there after in de-ionised water before the electrode is put into the buffer solution and in between every step of the buffer adjustment.

Redox electrodes

Redox electrodes require cleaning like pH electrodes, but not buffer adjusting.

However, MJK do deliver redox buffers for control of electrode and transmitter.

If the transmitter does not show the correct value when put into the buffer solution, the electrode must be exchanged.

Cleaning of elektrodes

Use clean potable water for cleaning the

electrode.

A 10% hydrochloric acid solution can be used for cleaning if the electrodes are greasy. Protein coatings is removed with Pepsin cleaning fluid (item number 163020).

Electrode lifetime

The expected lifetime of the electrodes is dependant of the measurement.

The lifetime is given with reservation as the physical conditions as well as the temperature, pressure and pollution of the fluid has great influence on the stated lifetime.

The lifetime is based on 25 °C, but if the temperature is doubled, the lifetime will be halved!

PH electrodes in purifying plants for ordinary household wastewater lasts approximately 1 year, whereas the lifetime of pH electrodes in industrial plants is dependent on measuring application and the process.

Redox electrodes have a lifetime of approximately 2 years, depending on cleaning.

Spares

Item no:	Description:
160310	pHix [®] pH electrode, 0-point=4,6 pH
160311	pHix [®] pH electrode, 0-point=7,0 pH
160312	pHix [®] redox electrode
570054	O-ring for electrode
571030	Black rubber gasket for electrode
521409	Union ring w. Viton gasket for mounting of pHix on pipe end
521441	Viton gasket for union ring

The followin is recommended for cleaning and buffer adjustment:

Item no:	Description:
163020	Pepsin solution, 0,25l
163030	pH buffer, 6 x 25ml ampoules. (2 pcs. pH 4, pH 7 and pH 10.)
163032	pH buffer, 1 liter pH 4
163034	pH buffer, 1 liter pH 7
163036	pH buffer, 1 liter pH 10
163040	Redox buffer, 6x25ml; +230 mV Pt-Ag/AgCl

Specifications

pHix [®] Compact	
Supply voltage	12-30 V DC
Consumption	App. 50mW
Temperature range	-20 ... +60 °C
Housing material	Ryton (PPS) and stainless steel (EN 1.4404 / ASTM 316L)
Enclosure	IP 68, withstands submersion to 10 mWG
Input	0-14 pH/-1000 ... +1000 mV
Input impedance	Measuring input: > 10 ¹² ohm Reference input: > 10 ⁶ ohm
Output	0-14 pH / 4-20 mA
Temperature comp.	-20 ... +80 °C
Temp. electrode	Built-in behind steel section.
Buffer adjustment	Automatic with tilt switch, switch ring or HART [®] command
Cable length	6 meter
CE approvals	EN50081-1, EN50082-1

Dimensions

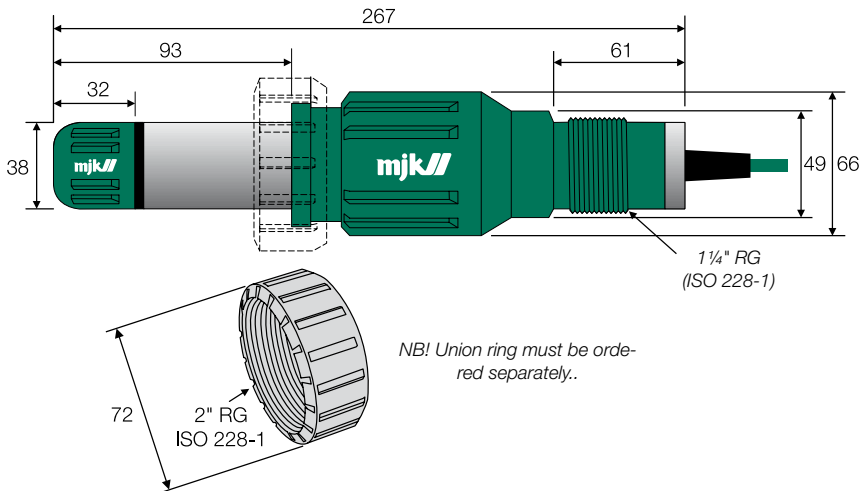

Appendices

Error codes

<i>Symptom / mA signal:</i>	<i>Fault:</i>	<i>Remedy:</i>
Constant current signal or I = 0 mA	Electrical connection is not made correctly.	Check connection and make the necessary corrections.
Unsteady current signal	Undervoltage.	Check the voltage at transmitter. Min. voltage @ max. load > 12 V DC!
I = 3.80 mA	Undervoltage.	Check the voltage at transmitter. Min. voltage @ max. load > 12 V DC!
I = 3.85 mA	Electrode error.	Exchange the electrode.
I = 3.90 mA	Calibration not possible.	Exchange the electrode.
I = 3.95 mA	pH lower than measuring range.	Readjust the measuring range to a lower range.
I = 4.00 mA	Error on startup.	Disconnect the transmitter from PSU for min. 5 seconds and try again.
I = 22.00 mA	pH higher than measuring range.	Readjust the measuring range to a higher range.

Standard transmitter configuration

The transmitter is standard configured as described below on delivery:

pH transmitter, item no. 203111:

Measuring range: 0-14 pH = 4-20 mA, 0-point = 4,6 pH

pH and temperature transmitter, item no. 203112:

Measuring range: 0-14 pH = 4-20 mA, 0-punkt = 4,6 pH, Temperature: 0-50° C = 4-20 mA

Redox transmitter, item no. 203121:

Measuring range: -1000 to +1000 mV = 4-20 mA

HART® commands:

All commands and settings can be read and set by means of HART® commands. Ask for separate documentation regarding HART® commands.

Accessories for mechanical mounting

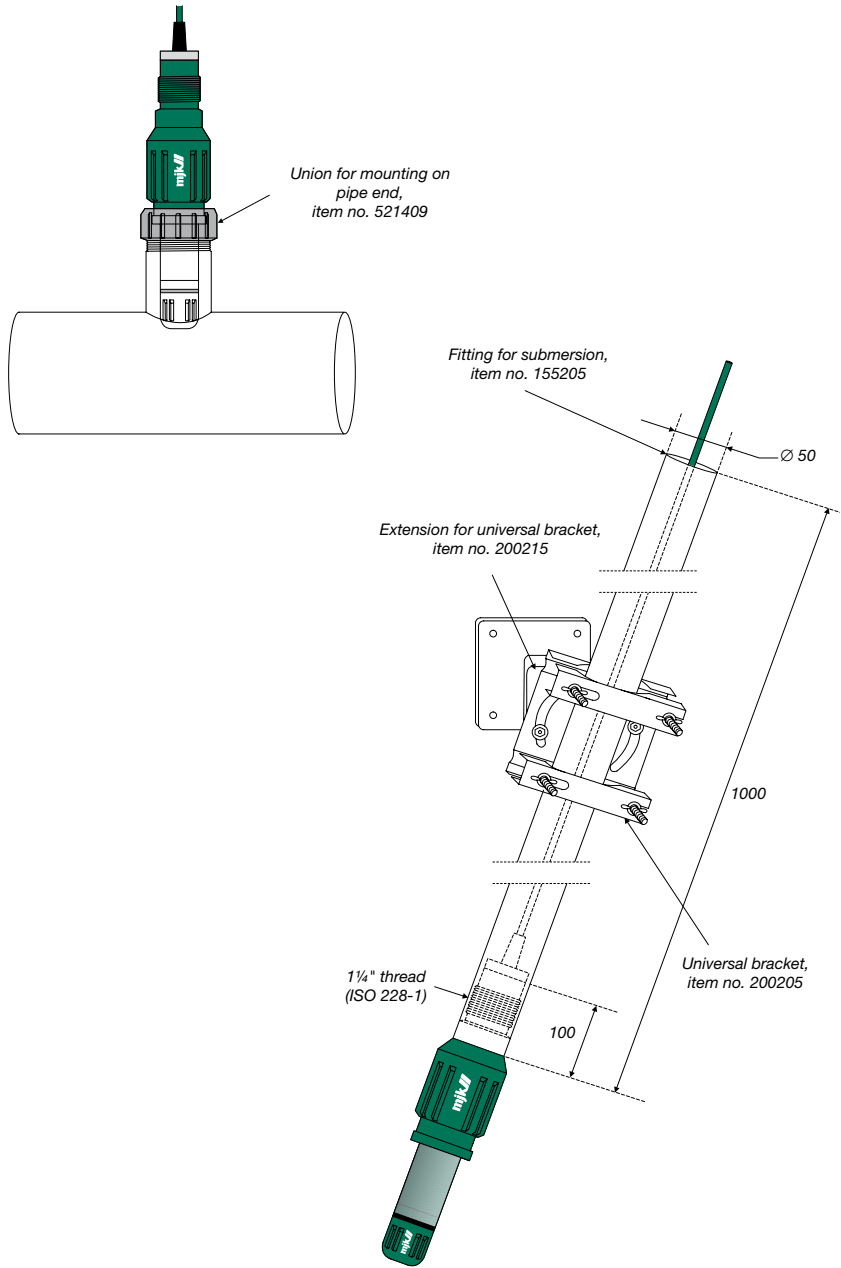

Accessories for electrical mounting

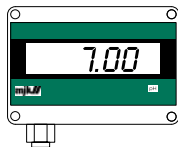

Loop supplied digital indicator
type 531, item no. 200125.
(See also data sheet 6.3.)



230 V AC digital indicator type
533 with built-in 24 V DC power
supply and 2 relay outputs for
alarm, control etc., item no.
200130.
(See also data sheet 6.3.)

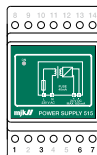

Power supply type 515,
item no. 200100.
(See also data sheet no. 6.3.)

Liability

MJK Automation A/S is liable to the common rules of Danish law on product liability. However, the liability is reduced to coverage of our public liability insurance of products. To the extent where nothing else follows in lines of invariable rules of law, we are not liable for loss of profits and working deficits or other indirect losses.

Changes

As our products are developed continuously, we reserve the right to make any alterations without prior notice.

MJK Automation A/S

DK: +45 45 56 06 56
NO: +47 69 20 60 70
SE: +46 53 31 77 50
NL: +31 251 672171
IRL: +353 879535625
USA: +1 847 482 8655
AUS: +61 3 9758 8533